

HOUNÖ PROTECT

MANUAL English

Visual Cooking® & CombiSlim® models

Software version 2_7_1 10/2021

Original English document

ENERGY & WATER METERS	3
Energy meter	3
Water meter	3
HOUNÖ PROTECT Hydro Shield water filter	4
CHEMICALS	5
COMBIWASH	6
Cleaning the oven chamber	6
PRODUCT LIST	7
HYDRO SHIELD INSTALLATION MANUAL	8
Connecting to water supply	8
WATER METER SETUP	11
Water meter setup for SmartTouch ovens	11
Water meter setup for HOUNÖ standard ovens	14
Filter capacity calculation	14
Hydro Shield system assembly instruction for Visual Cooking® II SE	16
Hydro shield system assembly instruction for CombiSlim®	17
REPLACEMENT OF THE WATER FILTER	18
Thank you for choosing HOUNÖ	19



This manual is an introduction to HOUNÖ PROTECT.

The HOUNÖ PROTECT product range is specifically designed and manufactured for daily usage in HOUNÖ combi ovens.

Version for the ovens software should be **1.3.4.** or higher. Choose  and press **USER** to see the software version.

ENERGY & WATER METERS

Energy meter

Energy usage is recorded in the oven. It is possible to set a counter to zero and record how much energy has been used in certain time.

There is a total counter, which will continuously record energy usage during the life span of the oven.

1. On the **Main Menu**, touch the settings wheel  to enter the settings menu.
2. Touch the Super user button
3. Scroll down and touch Logs & statistics
4. Touch Energy meters
 - Total counter will read all energy usage of oven.
 - Trip counter will read energy usage of oven since last reset. Information of previous reset will be shown under the Reset trip button.

Water meter

Water usage is recorded in the oven. It is possible to set a counter to zero and record how much water has been used since last reset.

Note: Water used for the hand shower and drain cooling function is not recorded

There is a total counter which will continuously record water usage during the life span of the oven.

1. On the **Main menu**, touch the settings wheel  to enter the settings menu.
2. Touch the **Superuser** button.
3. Scroll down and touch **Logs and statistics**.
4. Touch **Water meter**.
 - **Total counter** will read all water usage of the oven.
 - **Trip counter** will read the water usage of the oven since last reset.
 - **Reset trip** will reset the trip counter to zero. Date of previous reset will be displayed beside the **Reset trip** button.

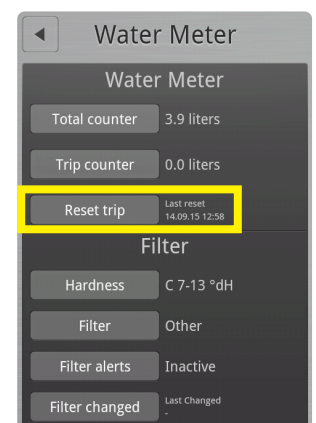
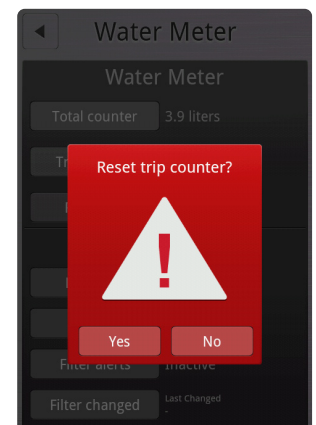
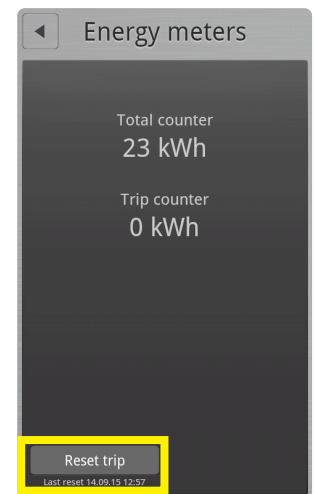
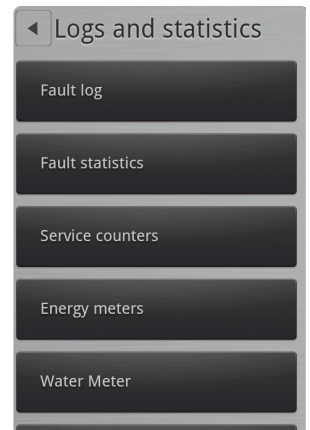

HOUNÖ PROTECT Hydro Shield water filter

The **Filter** function will record the usage of the HOUNÖ PROTECT Hydro Shield water filter and alert the oven user when the filter needs replacing. First, you need to measure the total hardness of the water input to the oven.

Water hardness tests can be purchased from www.houno.com/accessories.

To activate, do the following:

In the **Water meter** screen

1. Touch the **Hardness** button
2. Choose water hardness settings based on the results of the water hardness test.
 - Use **Simple** mode if you use the water test strips delivered with oven.
 - Use **Advanced** mode if you use the water drop test purchased from www.houno.com/accessories.
3. Touch the **Filter** button. Choose the corresponding HOUNÖ PROTECT Hydro Shield water filter size just installed on your oven. A confirmation screen will appear informing you if the filter alert status is active or inactive.
4. Touch the **Filter alert** button. Choose if you wish filter alerts to be **Active** or **Inactive**. Press **OK** to confirm.
5. Touch the **Filter changed** button to reset the counter so filter alerts will be accurate in alerting you of new filter needed.

Note: The **Filter alert** function is only compatible with the HOUNÖ PROTECT Hydro Shield water filters

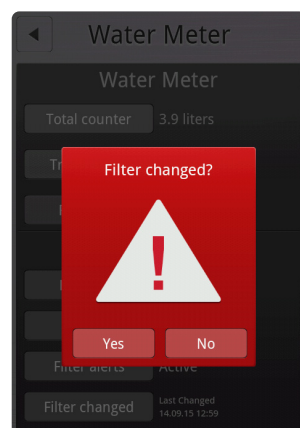
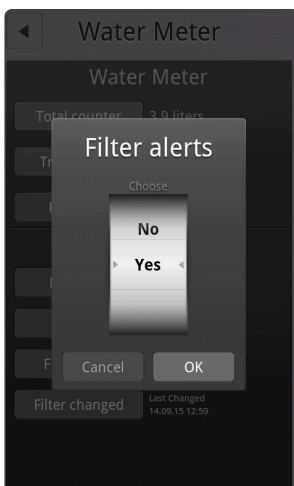
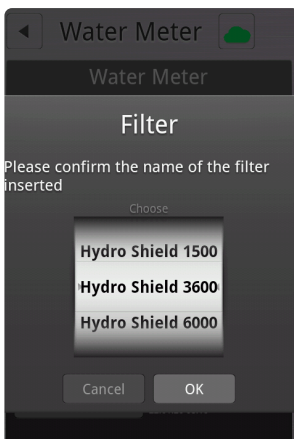
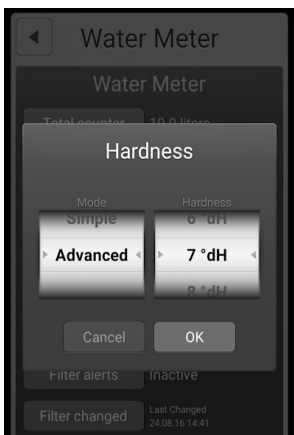
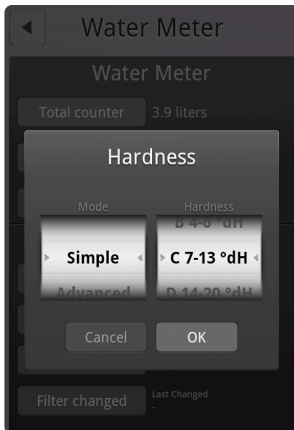

CHEMICALS

The **Chemicals** function will record the usage of the HOUNÖ PROTECT detergent and rinse aid levels. The oven will alert the user when the chemical containers need replacing. Chemicals and accessories can be purchased from www.houno.com/accessories.

To activate, do the following:

1. On the **Main menu**, touch the settings wheel  to enter the settings menu.
2. Touch the **Superuser** button.
3. Scroll down and touch **Logs and statistics**.
4. Touch the **Chemicals** button.

To activate do the following;

5. Touch the **Level Warnings** button.
6. Scroll to **Yes** and touch **OK** to confirm.
7. Touch the **Container** button. Here you are given the choice between 5 liters and 10 liters containers. Choose which size containers you have and press **OK** to confirm

Once the level warnings are activated and new chemicals have been added, the counter needs to be reset.

8. Touch the **Replaced** button. This will start the counter fresh so the usage of chemicals can be measured accurately to ensure of timely chemical replacement.

Next to the **Replaced** button is shown the date of the previous chemical replacement. Use the same process for the rinse aid. The level will show  if chemicals are still available.

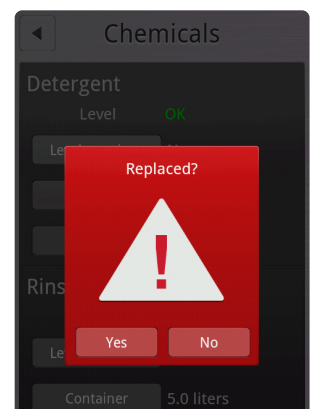
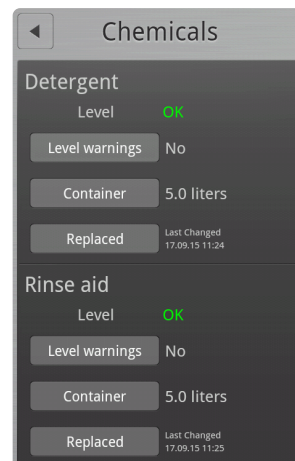
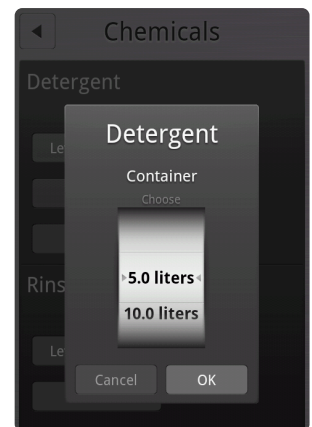
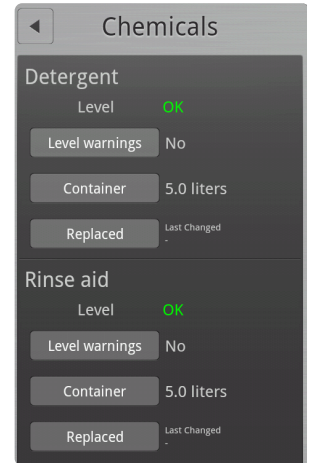

COMBIWASH®

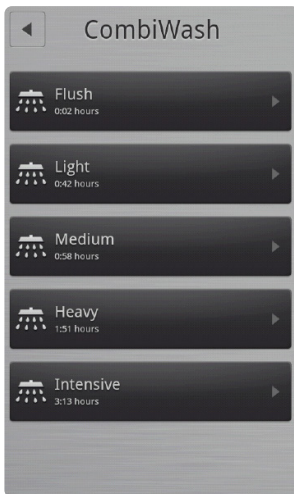

We recommend that you clean the oven daily to maintain efficiency and to ensure a high level of sanitation. Located under the front panel is a spray hose you can use to clean the oven after it has cooled down.

Cleaning the oven chamber

1. Check the level of detergent and rinse aid in the containers. The red tube is for detergent and the blue tube is for rinse aid.
2. On the **Main menu**, touch **Manual**, and then touch **Combiwash®**.
3. Touch the desired cleaning mode. You can choose between the following cleaning cycles.
 - **Flush:** Use this before starting the other cleaning programmes.
 - **Light:** Use this after steaming and roasting at low temperatures.
 - **Medium:** Use this after steaming and roasting at medium temperatures.
 - **Heavy:** Use this after roasting at temperatures higher than 180°C.
 - **Intensive:** Use this after roasting very greasy products.
4. Touch **Start**.

NOTE: If the cleaning cycle is interrupted before it has been completed, for example because of a power outage, the oven automatically performs a safety flush to remove any detergent remnants.

NOTE: The Combiwash® function is specifically developed for HOUNÖ PROTECT chemicals. Using other chemicals can cause damage to the oven and void warranty.

PRODUCT LIST

HOUNÖ PROTECT detergent intense

Detergent for cleaning ovens with the automatic cleaning system. The combination of alkaline, surface-active and calcium binding components ensures effective removal of dirt and hard stuck components. Furthermore, it prevents calcium deposits in hard water.

Use rinse aid in addition to detergent intense.

HOUNÖ PROTECT rinse aid

Concentrated, acidic rinse aid, specially developed for ovens with an automatic cleaning system. The product contains low-foaming components, which ensures fast streak-free drying. Furthermore, the product contains acidic components keeping the oven free from calcification.

HOUNÖ PROTECT Hydro Shield water filter

The HOUNÖ PROTECT Hydro Shield water filter pack contains the filter cartridge with hygiene cap and the installation and operating instructions.

The Hydro Shield system is used to remove total hardness from cold water and is recommended for use for machines susceptible to corrosion.

- The HOUNÖ PROTECT Hydro Shield water filter reduces the scale content of tap water and thus protects the combi steamer, bake off oven or other HORECA equipment from harmful limescale deposits.
- HOUNÖ PROTECT Hydro Shield water filter prevents gypsum precipitation in machines by removing calcium bound to sulphate.
- HOUNÖ PROTECT Hydro Shield water filter removes unpleasant odours and tastes, e.g. chlorine. Water is also filtered of particles.

Information and shop: www.houno.com/accessories.



HYDRO SHIELD INSTALLATION MANUAL

Connecting to water supply

The Visual Cooking® oven comes with two water connections by default. A special adapter is provided so the oven can operate with a single water input. See description below.

Use a local legislation approved flexible connection hose to connect to the water supply. Permanent water supply connections must be fitted with a stop tap.



Flush the tubes thoroughly before you connect the oven to the water supply.

Supply water specifications

- Hardness of the water: maximum 3 dH.
- Conductivity: minimum 75 microsiemens.
- Minimum inlet water pressure: 250 kPa (2.5 bar, 36 PSI) dynamic pressure when using CombiWash®.
- Maximum inlet water pressure: 600 kPa (6 bar, 87 PSI) dynamic pressure when using CombiWash®.
- Water flow: minimum 12 liter/minute.
- Water temperature: maximum 20°C (68°F).
- Chloride concentration max. 100 mg/liter.
- Sulphate: maximum. 150 mg/liter.
- Chlorine: 0 parts per million.
- pH Factor: 7.0-8.0.
- If the water feeder is connected to the water supply with a flexible connection hose, the hose should comply with local rules and regulations.



NOTE: Oven damage due to absence of a necessary HOUNÖ PROTECT Hydro Shield water filter may render the warranty void.



NOTE: Oven damage due to lack of regular cleaning with HOUNÖ PROTECT detergent intense and rinse aid may render the warranty void.



If the water temperature exceeds 20°C/68°F, you may experience issues with ClimaOptima® calibration and cooling.



The warranty does not cover clogged up water filters or dirt in the solenoid valves.



To ensure that the water quality matches the requirements, we recommend that you install a HOUNÖ PROTECT Hydro Shield water filter in the water supply line.



The water supply connection must be carried out by an authorized plumber in compliance with local rules and regulations



Water that does not meet the specified requirements can damage the oven in form of corrosion. Ovens damaged/corroded by water that does not meet the specification are not covered by warranty.

HOUNÖ PROTECT Hydro Shield water filter is available in three different filter sizes. The water filters can be purchased directly at www.houno.com/accessories.

Water hardness

HOUNÖ provides two different tools to measure the hardness of the water: test strips and droplet test.

Test strips:

Test procedure:

- Take a raw water sample, contain it in a sample cup or a similar sized container.
- Put the test strip in the raw water sample for approximately one second (make sure that all four test zones are beneath the water surface).
- Shake off excess liquid from the strip.
- After one minute, the 0 to 4 of the test zones will change colour from green to red, indicating the hardness of the supply water.



For external water meter use the matrix on page 25 to determine the filter size.

Droplet test:

Test procedure:

- Flush the vial and fill it with 10 ml raw water.
- Add the test fluid one drop at the time.
- Count the drops until the colour changes from red to green.
- One drop = 1 dH.

For external water meter use the matrix on page 26 to determine the filter size.



Installation with water treatment

Connections for oven installation in areas where the conditions of the raw water demands a water filter; there is one connection for the steam generator and the jets in the oven chamber. This connection must comply with local rules and regulations for water supplied to household appliances. Water temperature must never be more than 20°C/68°F. The connection is located next the front of the oven (2). There is one connection for the hand shower and drain cooling. The connection is the one closest to the back of the oven (1).

VISUAL COOKING® II SE
With filter

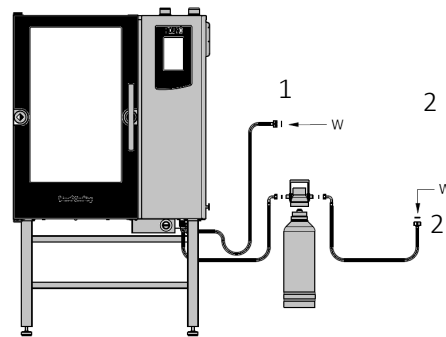

VISUAL COOKING® II SE COMBIPLUS®
With filter

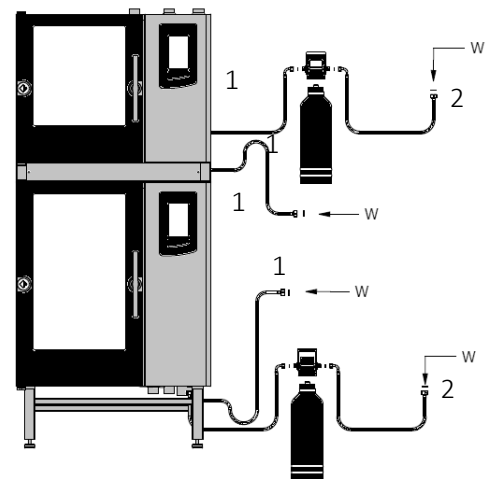

WARNING When connecting a CombiPlus® oven to the water supply, ensure that you have separate water connections for the top and bottom oven.

COMBISLIM® II - with filter
CombiSlim® ovens have two water inlets.

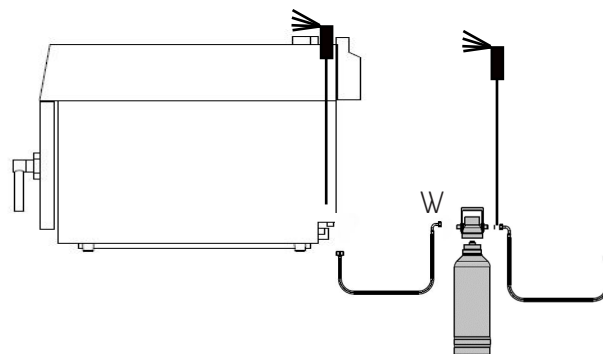

WATER METER SETUP

Water meter setup for SmartTouch ovens

HOUNÖ ovens with SmartTouch display have a water meter build in the software.

The innovative software in HOUNÖ SmartTouch ovens works together with the HOUNÖ PROTECT products to give you the best protection and lowest running cost. The oven monitors the consumption and tells you when to change detergent, rinse aid and water filter.

For this function to work as intended, the CPU need to be set up with the right water hardness and filter size. Follow the below step-by-step description.

Water meter setup

1. Switch on the oven by pressing the on/off button.
2. At the **Main menu**, press the gear wheel  in the upper righthand corner.

3. Select the **Superuser** menu.

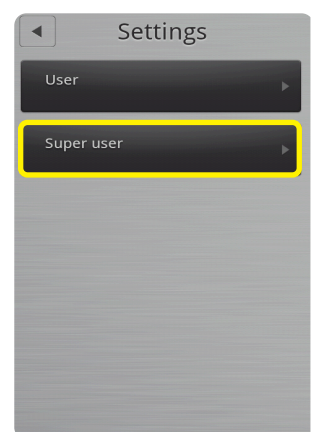
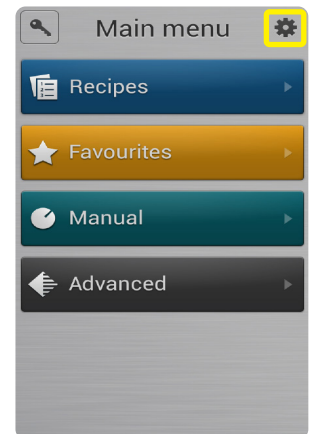

4. Select: **Logs and Statistics** menu.

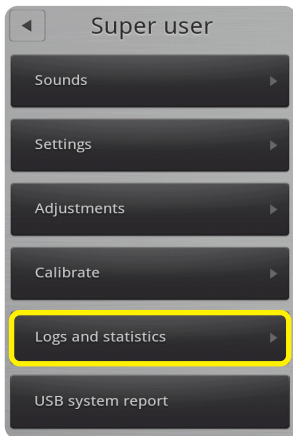

5. Select **Water meter**.

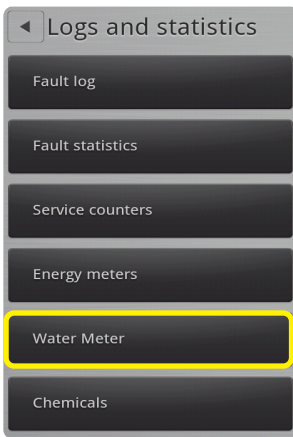

6. Select **Hardness**, and select the measured hardness method: **Simple** or **Advanced**. Set the hardness of the water to measure water hardness.

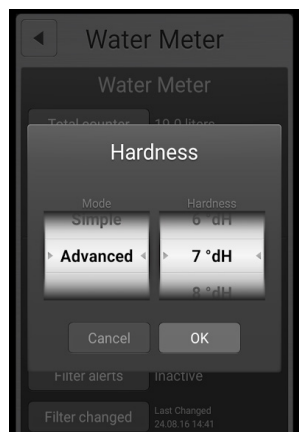
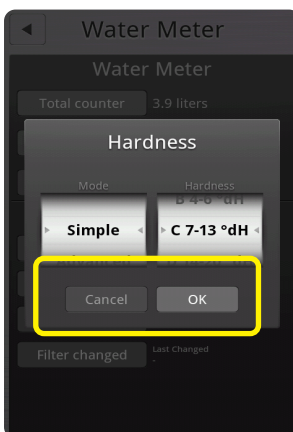

7. Select: Hydro Shield filter size to select the filter size which is fitted to the supply line.

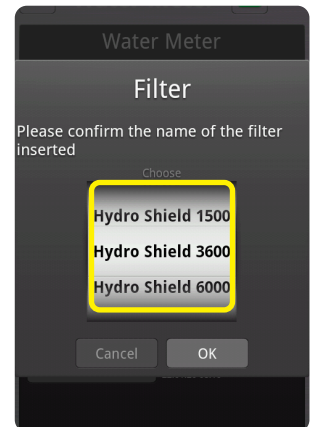

8. Select **Filter alerts** and activate the filter alarm. In this way, the oven will let the user know when the filter need to be replaced.

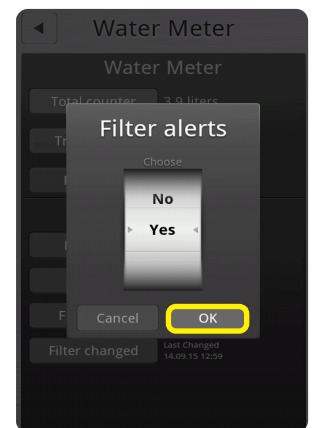

9. Select **Filter change**, and reset the liter counter for the filter capacity. Now the water meter is reset and ready for use.

The oven is now set up to give a warning when the filter needs to be changed.

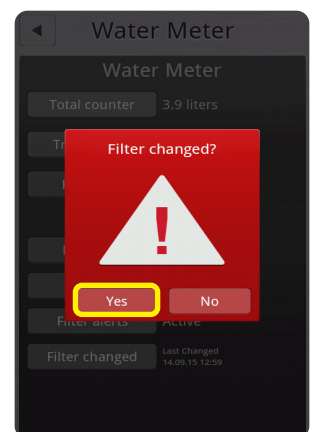

Water meter setup for HOUNÖ standard ovens



All standard ovens must be fitted with an external water meter. The external water meter can be purchased directly from our webshop www.houno.com/accessories. A manual for setting up the external water meter is available for download from our webshop.

Programming of water meter

- | | |
|---|----------------------------|
| 1. Press once Prog. | Display flashes "PRG" |
| 2. Press once Reset. | Last digit flashes |
| 3. Press the Reset until the desired number appears. | |
| 4. Press once Prog. | Switches to the next digit |
| 5. Repeat step 3 and 4 until the desired value is entered | 5 digits |
| 6. To exit, press Prog. | The capacity is set. |

Resetting the capacity by replacing the water filter

1. Press **Reset** for 3 seconds.

Filter capacity calculation

When setting up the water meter, it is vital to know the liter capacity of the HOUNÖ PROTECT Hydro Shield water filter.



Using test strips for water hardness test

Use the strips test procedure as described on page 9.

HYDRO SHIELD FILTER SYSTEM FILTER SIZE								
Hardness test				1,500	3,600	6,000		
				[l]	[l]	[l]		
	dH	Strips						
A	0-3	Green	Green	Green	Green	5000	11966	20000
B	4-6	Red	Green	Green	Green	2500	5980	10000
C	7-13	Red	Red	Green	Green	1150	2420	4615
D	14-20	Red	Red	Red	Green	750	1570	3000
E	21-25	Red	Red	Red	Red	600	1175	2400

Using the droplet water hardness test

Use the strip test procedure as described on page 9t

HYDRO SHIELD FILTER SYSTEM FILTER SIZE			
Hardnes test [drops]	1,500 [l]	3,600 [l]	6,000 [l]
2	7500	17950	30000
3	5000	11966	20000
4	3750	8975	15000
5	3000	7180	12000
6	2500	5983	10000
7	2140	5125	8570
8	1875	4458	7500
9	1665	3985	6665
10	1500	3590	6000
11	1360	2860	5455
12	1250	2620	5000
13	1150	2420	4615
14	1070	2245	4285
15	1000	2100	4000
16	935	1965	3750
17	880	1850	3525
18	830	1745	3330
19	785	1655	3155
20	750	1570	3000
21	710	1400	2855
22	680	1335	2725
23	650	1275	2605
24	625	1225	2500
25	600	1175	2400
26	575	1130	2305
27	555	1090	2220
28	535	1050	2140
29	515	1010	2065
30	500	980	2000



Hydro Shield system assembly instruction for Visual Cooking® II SE

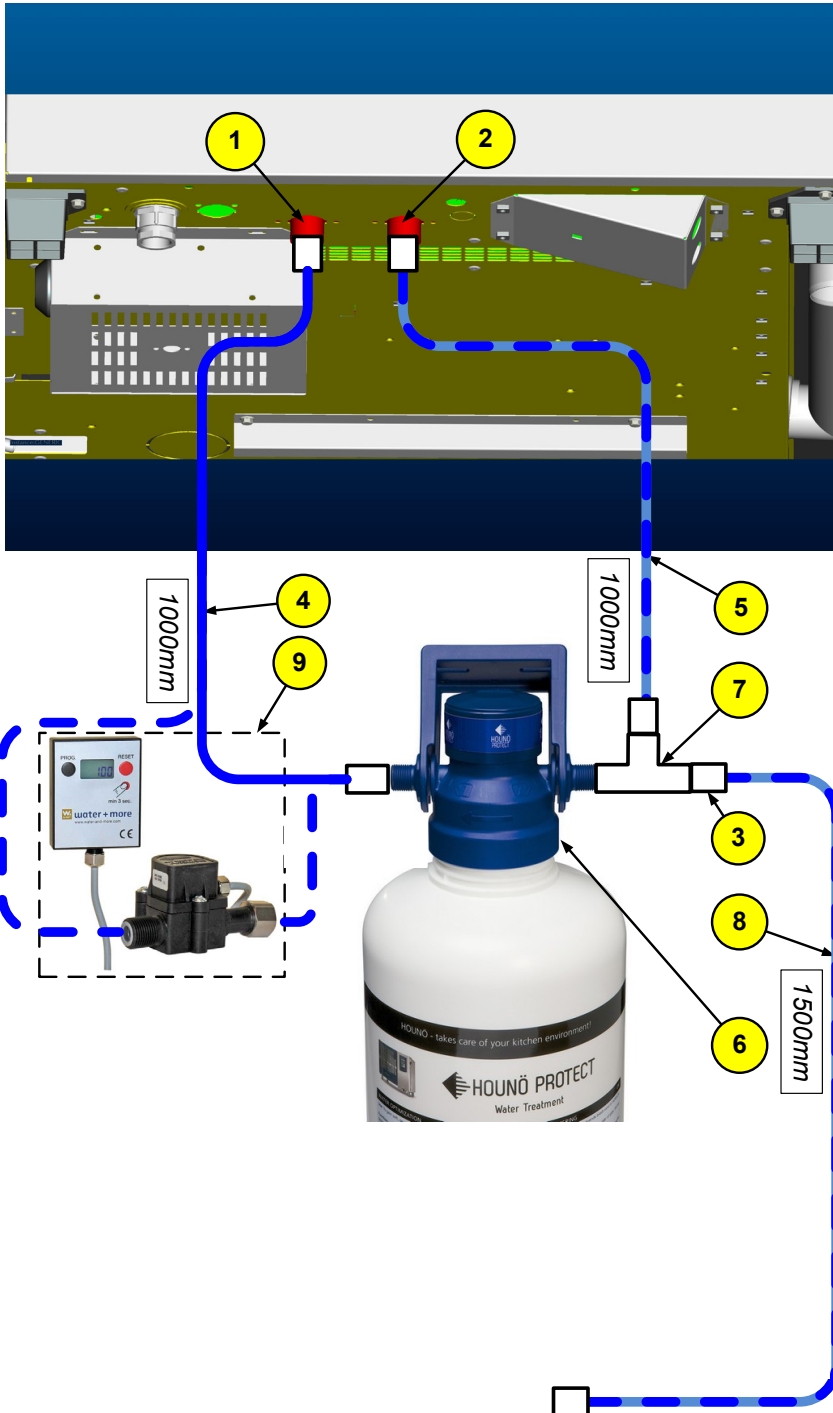

IMPORTANT INFO. If the oven does not have a build-in water meter, it is vital to fit a water meter to the Hydro Shield system. As option below (9)

1. Fit the T-fitting to the inlet port on the Hydro Shield system (7).
2. Fit the 1500 mm water supply line (8) to the water outlet in the kitchen, and to the T-fitting on inlet port on the Hydro Shield system.
3. Fit a 1000 mm hose (5) from the T-fitting (7) to the inlet port on the solenoid valve (2). This is unfiltered water.
4. Fit a 1000 mm hose (4) to the outlet port on the Hydro Shield system and directly to inlet port on the solenoid valve (1) on the oven. This is filtered water.

Filter head bypass set to "0".

Item name

- | | |
|---|---------------------------|
| 1 | Valve inlet |
| 2 | Valve inlet |
| 3 | Fitting |
| 4 | Hose, 1000 mm |
| 5 | Hose, 1000 mm |
| 6 | Hydro Shield water filter |
| 7 | T-fitting |
| 8 | Water inlet hose, 1500 m |
| 9 | Water meter |

Hydro shield system assembly instruction for CombiSlim®

IMPORTANT INFO. If the oven does not have a build-in water meter, it is vital to fit a water meter to the Hydro Shield system. As option below (7)

1. Fit the 1500 mm water supply line (6) to the water outlet in the kitchen and directly to the inlet port at the Hydro Shield system.
2. Fit the T-fitting from the hand shower kit (5), to the inlet port on the solenoid valve on the oven (1).
3. Fit a 1000 mm hose (3) from the outlet port on the Hydro Shield system to T-fitting. This is filtered water.

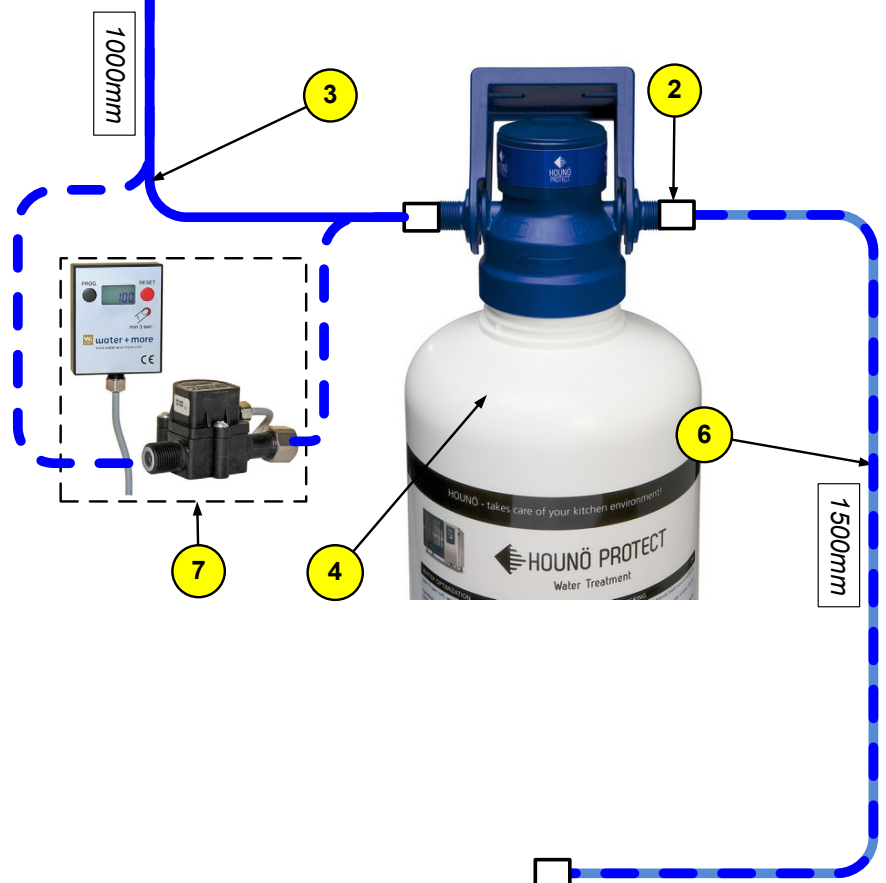
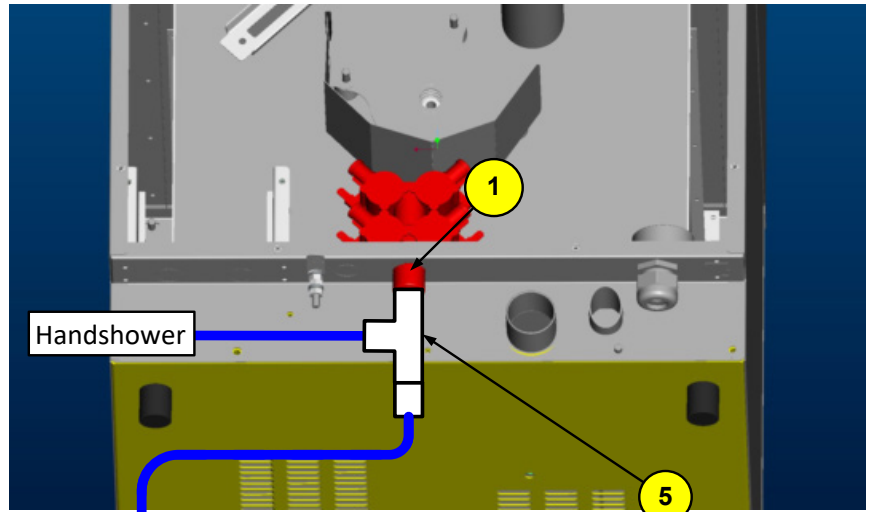

Filter head bypass set to "0".

Item name

- | | |
|---|---------------------------|
| 1 | Valve inlet |
| 2 | Hose fitting |
| 3 | Hose, 1000 mm |
| 4 | Hydro Shield water filter |
| 5 | T-fitting |
| 6 | Hose, 1500 m |
| 7 | Water meter |

REPLACEMENT OF THE WATER FILTER

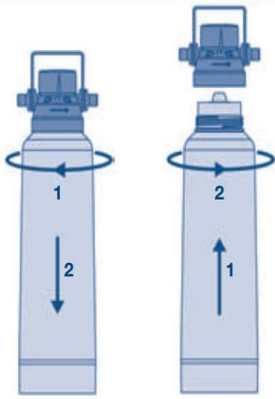

The Hydro Shield water filter must be replaced when the oven display (or connected water meter) shows that the capacity is used up.

The Hydro Shield water filter must be replaced on a regular basis and no later than 12 months after installation.

After a shutdown of four weeks or more, the Hydro Shield water filter must be replaced by a new one.

Removal

Remove the water filter by turning clockwise and pull out of the filter head.



Be aware that the water filter is heavy; it is full of water!

Mounting

1. Take the Hydro Shield water filter from the packaging and remove the hygiene cap.
2. Before installing the Hydro Shield water filter, mark the installation date and the replacement date (no later than 12 months) on the filter.
3. Turn the Hydro Shield water filter anticlockwise in the filter head.
4. Reset the water meter. Ensure that filter models and water hardness are set correct.



Thank you for choosing HOUNÖ

Our Scandinavian roots are strong, as HOUNÖ combi ovens have been designed and produced in Randers, Denmark since 1977. We are Scandinavian in mind and behavior and we cherish credibility, quality, simplicity and design.

HOUNÖ PROTECT detergents and water filters are developed for maintenance of your HOUNÖ combi oven. At www.houno.com/accessories, we offer a wide assortment of professional cleaning products for combi ovens. Our products include water filters, steel care products, solution for decalcification as well as degreasers and detergents.

We hope that you have found this manual to be easily accessible and that using HOUNÖ PROTECT range your combi oven will be looking fresh and new for longer period of time.

Congratulations on choosing HOUNÖ!

Sincerely,

Your HOUNÖ team



HOUNÖ A/S
ALSVEJ 1
DK-8940 RANDERS SV
DENMARK

T: +45 8711 4711
E: houno@houno.com

www.houno.com
www.houno.com/accessories